

INSTALLATION GUIDE - WM2030

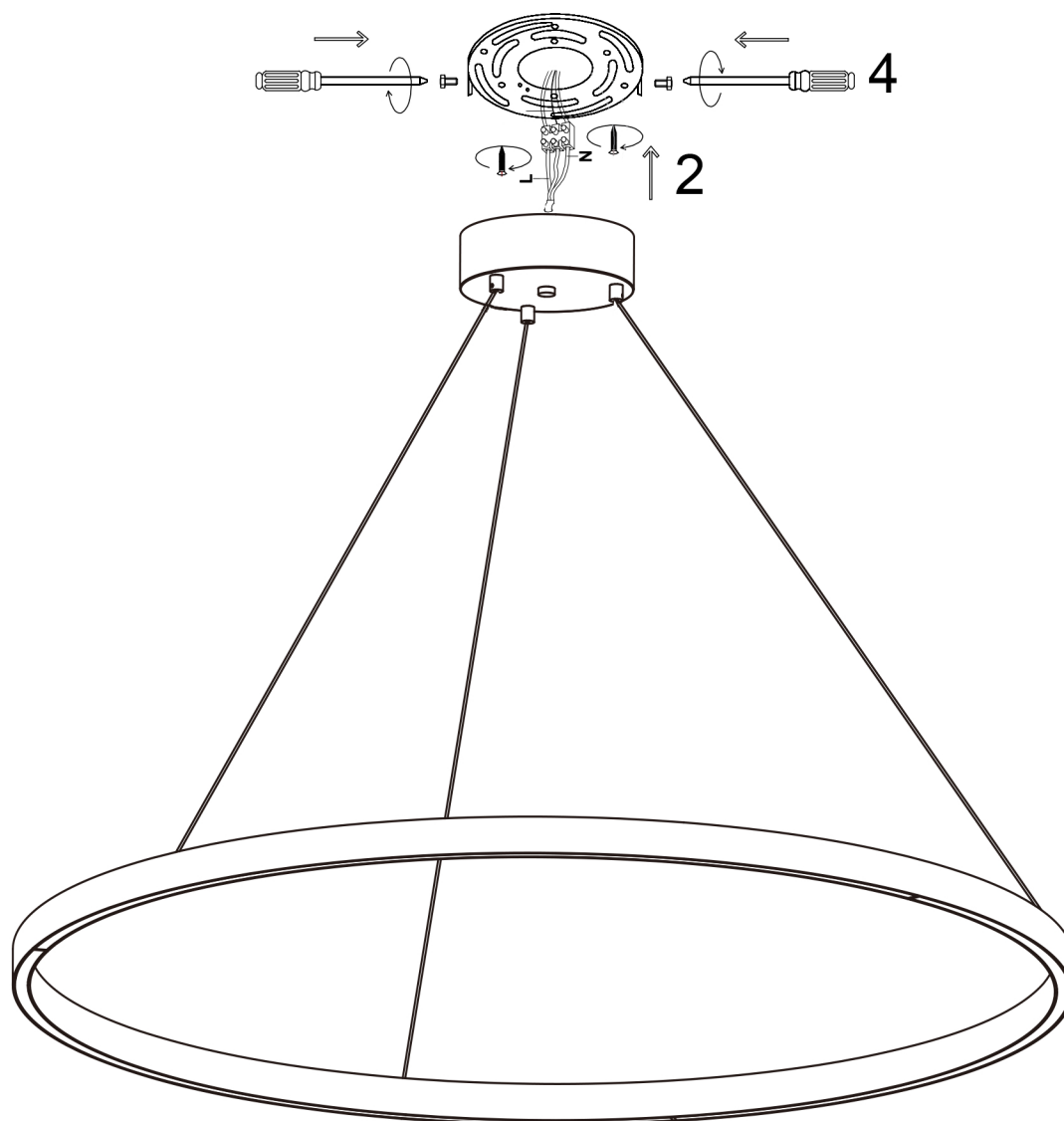

- 1. Drill the mounting bracket into the ceiling with screws and anchor bolts (these come with the light).**
- 2. Use the wire connector to connect the wires of the light to the supply wires according to labels on the wires.**
- 3. Align holes of the canopy with the mounting bracket and secure the canopy with screws.**
- 4. Turn the power back on and flip on the light switch to test your light.**