

INSTALLATION GUIDE - WM1000

Flower Shape Ceiling Lamp Installation Instructions

Model:TQ-42

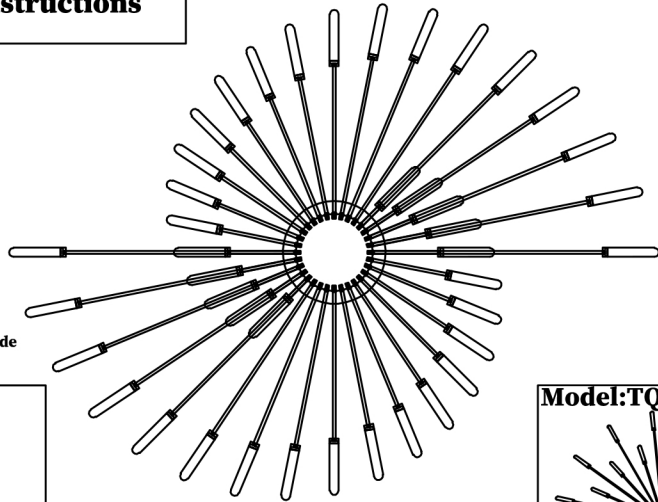

Model:TQ-28

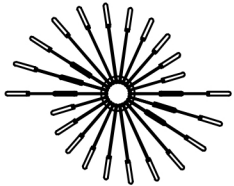

Model:TQ-30

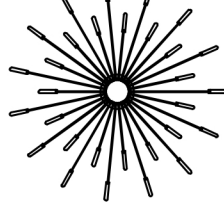

Note: The installation steps of TQ-30 and TQ-28 are the same as the steps of the TQ-42 as seen in the pictures.

Step1:Open the package and take the ceiling light out. Then Fix each lamp arm tightly into the base with the nuts as shown in the figure.

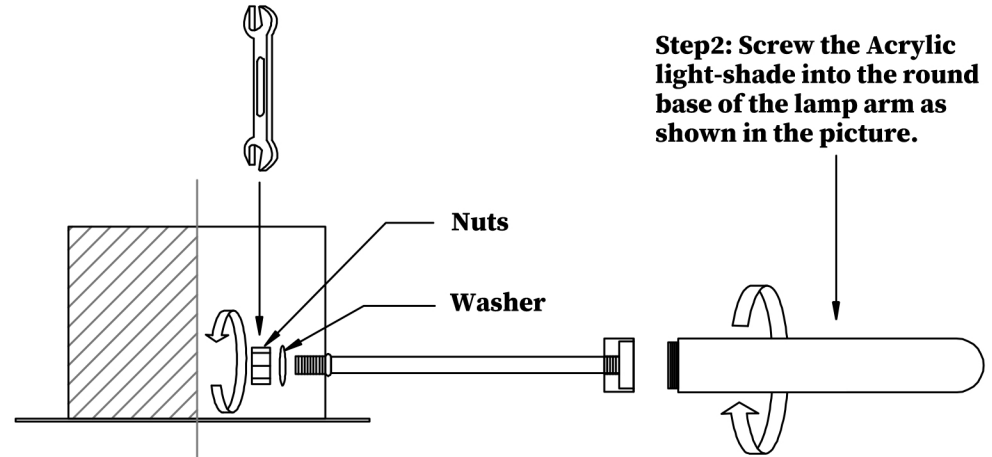

Step2: Screw the Acrylic light-shade into the round base of the lamp arm as shown in the picture.

Step3:As seen in the Picture.Fix the hanging plate on the ceiling of your room with the screw from the Accessory package.

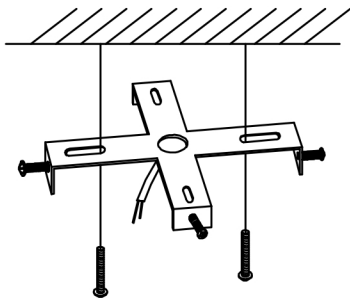

Step4:Then connect the input terminal of the lamp driver to Household Powerline as shown in the picture.

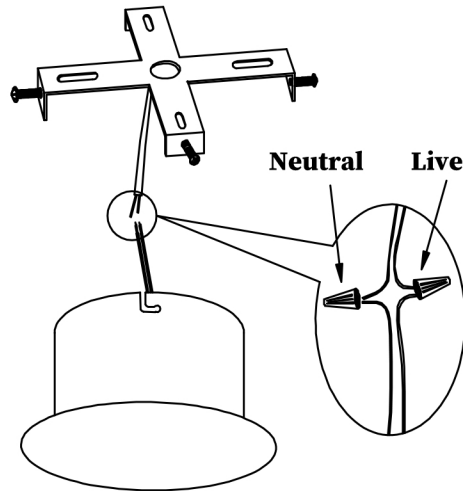

Step5:Lift the lamp base up and Rotate a small angle to let the screw into the hole corner of the base as shown in the picture.Finglly fix the lamp base on the banging plate with screw.

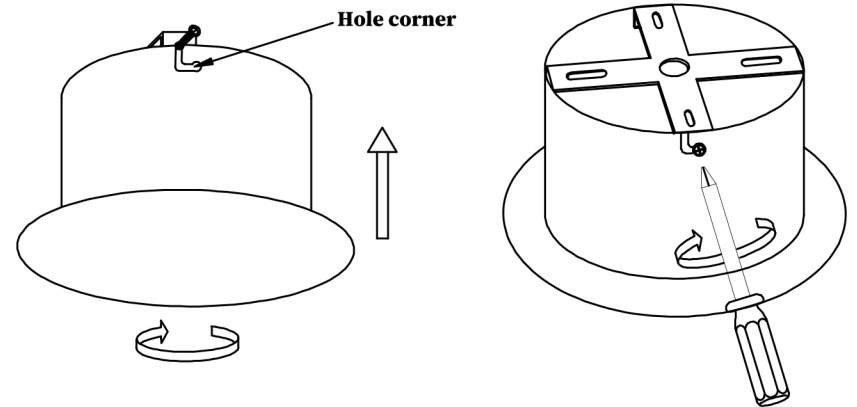

Note: If you have any question about the lamp & the installation,please fell free to contact winth us.And you can also see the video of the Installation Instruction in the Product Homepage.