

Warning:

This product must be installed by personnel who are familiar with its structure and related hazards, in accordance with the installation specifications. This product is suitable for indoor installation.

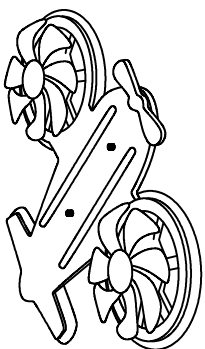

Product style diagram

Steps of installation

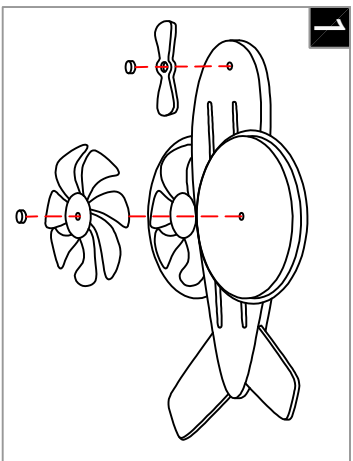

1 First, install the fan blades onto the lamp body, and then attach the propeller to the lamp body as well.

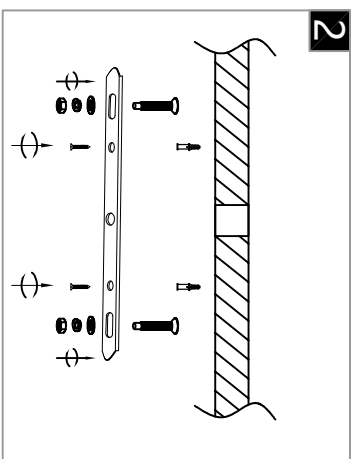

2 First, fix the expansion screws onto the ceiling, and then lock the mounting plate onto the screws.

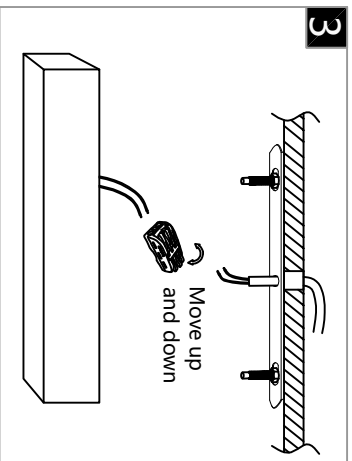

3 Connect the wires inside the luminaire and ceiling to the terminal, usually neutral wire (white), hot wire (black)

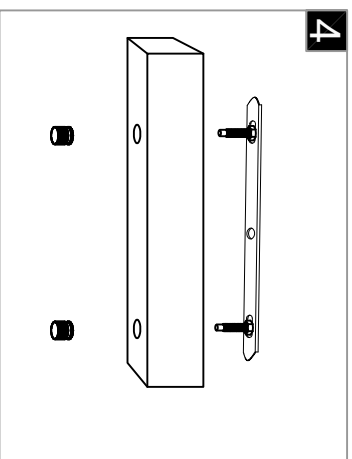

4 Align the bottom holes on the top cover with the screws on the mounting plate, and then tighten them with a wing nut

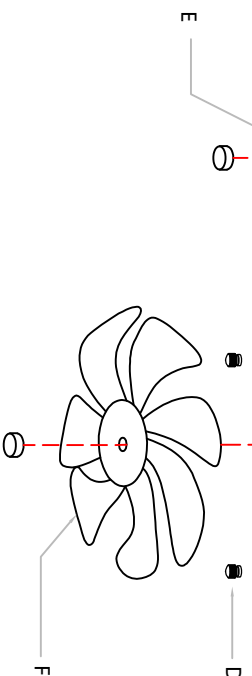
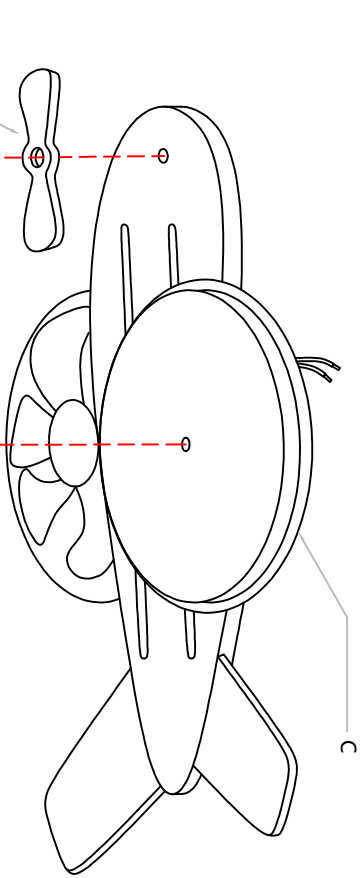
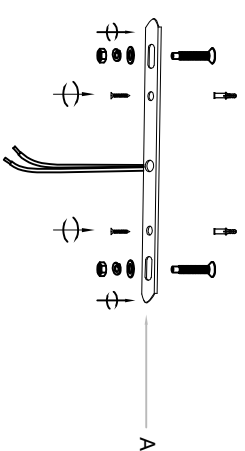

First, install the fan blades (F) onto the lamp body (C), then install the propeller (E) onto the lamp body (C) as well. Next, install the mounting plate (A) onto the ceiling. Then connect the lamp body (C) and the reserved wires on the ceiling to the terminal block (B). After that, align the holes on the lamp body (C) with the screws on the mounting plate (A), and then lock it in place using the wing nut (D).